



UL NO.	E481445
LIGHT OUTPUT	365 lumens
CCT	3000K
BEAM ANGLE	40°
CBCP	531.9 cd
WATTAGE	5W
EFFICACY	73 lm/W
APPLICATION	Incandescent replacement for indoor dry/damp applications.

SKU: SE-350.167



COLOR RENDERING: CRI>90, R9>50

FLICKER <30%

High quality of light and low flicker, listed with California Energy Commission's (CEC) JA8/Title 24 standard for quality of light, the most stringent in North America.

ENERGY EFFICIENCY: 73 lm/W

LONG LIFE: 25,000 hours.

Listed for energy efficiency by the CEC for Title 24, insuring high efficacy with a high quality of light.

- ✓ Rated lifetime to L70: 25,000 hours.
- ✓ Warranty: 3 years.

CERTIFICATIONS AND APPROVALS

UL, ES, CEC TITLE20, CEC JA8/TITLE24



HIGHLY COMPATIBLE

Compatible with standard fixtures using an GU5.3 base.

DIMMABLE

Smooth dimming with most existing installations. Dimmable to 1% when used with specific dimmers. See dimmer compatibility chart for details on operation and compatibility.

INTENDED USE AND APPLICATIONS

35W incandescent replacement.

Intended for use in GU5.3 compatible existing fixtures.

Suitable for dry or damp locations.

Not for use in fully enclosed fixtures.

Remove or do not use any optional glass lens in front of lamp.

GENERAL SPECIFICATIONS

Electrical Specifications		Operating Temperature	Mechanical Spec.
Wattage: 5W	Voltage: 12V	Minimum: -20°C	Measures: 1.97in X 1.96in
Power Factor: 0.9	Frequency: 60Hz	Maximum: 40°C	Weight: 1.38oz

DIMENSIONS

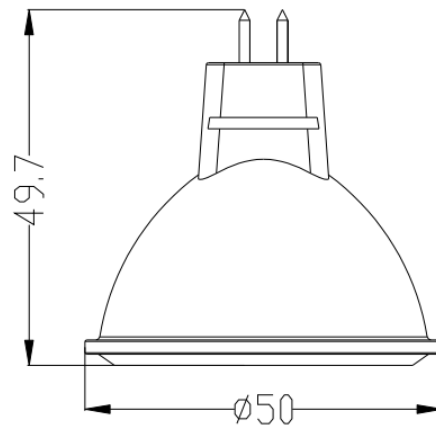

LUMINOUS INTENSITY

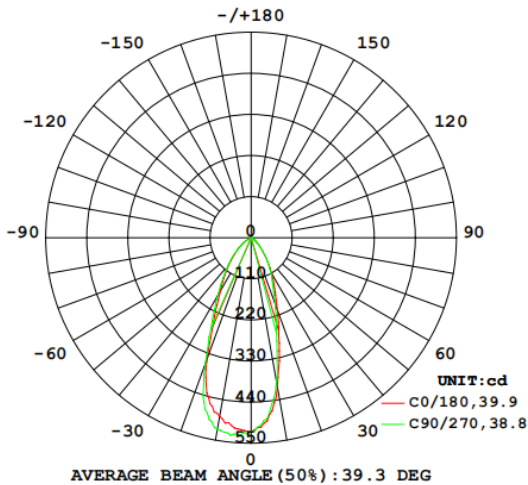

SPECTRAL DISTRIBUTION

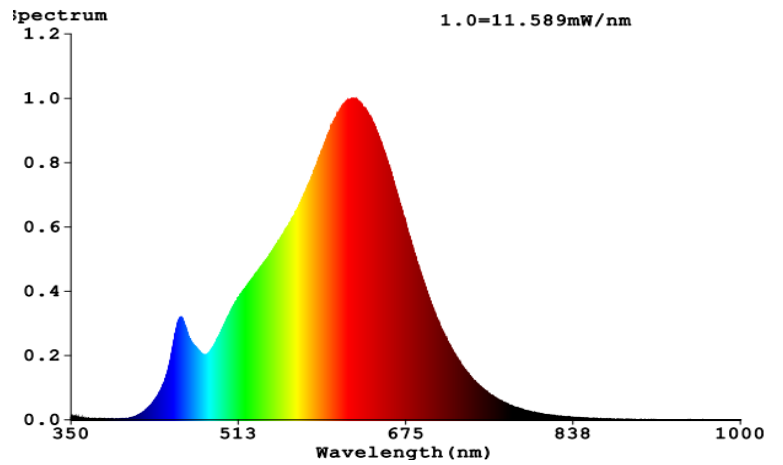

RA - CHART: >90

CRI VALUES | R1-R15

