



UL NO.	E497084
OUTPUT	350 lumens
COLOR TEMPERATURE	2200K
DISTRIBUTION	360°
WATTS	3.8
EFFICACY	92 lm/W
APPLICATION	Incandescent replacement for indoor dry/damp applications requiring high color quality and efficacy.

SKU: SE-350.122



COLOR RENDERING: CRI>90, R9>50

High quality of light and low flicker.

ENERGY EFFICIENCY: 92 lm/W

LONG LIFE: 15,000 hours.

Listed for energy efficiency by the CEC for Title 20, insuring high efficacy with a high quality of light.

- ✓ Rated lifetime to L70: 15,000 hours.
- ✓ Warranty: 3 years or 15,000 hours., whichever occurs first.

CERTIFICATIONS AND APPROVALS

UL, CEC TITLE 20



HIGHLY COMPATIBLE

Compatible with standard fixtures using an E26 base.

DIMMABLE

Smooth dimming with most existing installations. Dimmable to 1% when used with specific dimmers. See dimmer compatibility chart for details on operation and compatibility.

INTENDED USE AND APPLICATIONS

40W incandescent replacement. Intended for use in E26 compatible existing fixtures and table lamps. Suitable for dry or damp locations. Not for use in fully enclosed fixtures. Remove or do not use any optional glass lens in front of lamp.

GENERAL SPECIFICATIONS

Electrical Specifications		Operating Temperature		Mechanical Spec.	
Wattage: 3.8W	Voltage: 120V	Minimum: -20°C		Measures: 3.15in X 4.72in	
Power Factor: >0.8	Frequency: 60Hz	Maximum: 40°C		Weight: 1.41oz	

DIMENSIONS

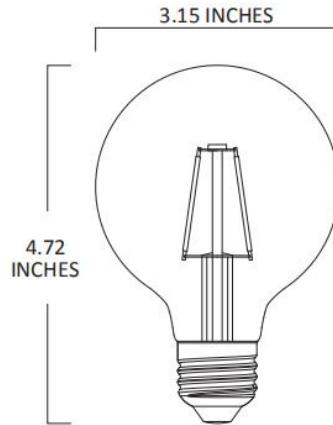

Luminous Intensity

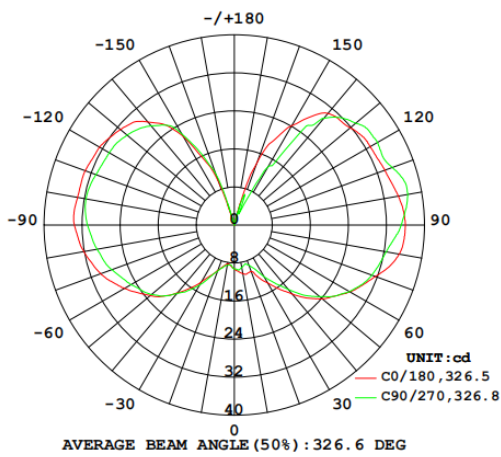

Spectral Distribution

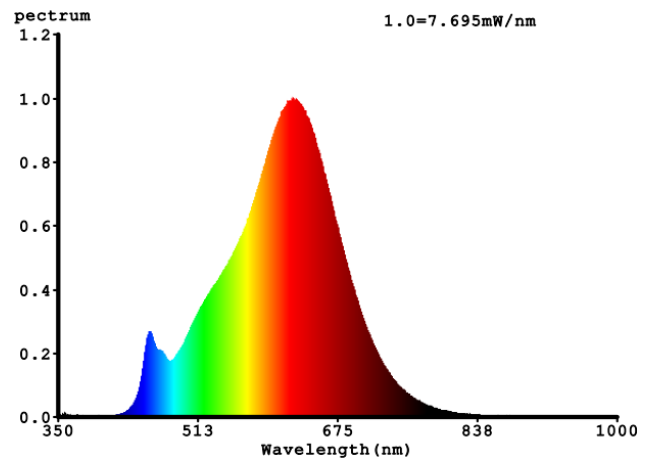

RA – CHART: 92

CRI VALUES | R1-R15

