



SKU: SE-350.064

LIGHT OUTPUT	1100 lumens
CCT	3000K
BEAM ANGLE	100°
WATTAGE	15W
EFFICACY	73 lm/W
POWER FACTOR	0.9
APPLICATION	Incandescent replacement for indoor dry/damp applications. Suitable for Use in Enclosed Fixtures.



COLOR RENDERING: CRI>90, R9>50

FLICKER <30%

High quality of light and low flicker, listed with California Energy Commission's (CEC) JA8/Title 24 standard for quality of light, the most stringent in North America.

ENERGY EFFICIENCY: 73 lm/W

LONG LIFE: 30,000 hours.

Listed for energy efficiency by the CEC for Title 20, insuring high efficacy with a high quality of light.

Lamps are also listed by Energy Star.

- ✓ Rated lifetime to L70: 30,000 hours.
- ✓ Warranty: 3 years

CERTIFICATIONS AND APPROVALS

ETL, ES, CEC TITLE 20, CEC JA8/TITLE24



HIGHLY COMPATIBLE

Compatible with standard fixtures using an E26 base.

DIMMABLE

Smooth dimming with most existing installations. Dimmable to 1% when used with specific dimmers. See dimmer compatibility chart for details on operation and compatibility.

INTENDED USE AND APPLICATIONS

Intended for use in E26 compatible existing fixtures.

Suitable for dry or damp locations.

Not for use in fully enclosed fixtures.

Remove or do not use any optional glass lens in front of lamp.

GENERAL SPECIFICATIONS

Electrical Specifications		Operating Temperature		Mechanical Spec.
Wattage: 15W	Voltage: 120V	Minimum: -20°C	Measures: 7.36in X 3.18in	
Power Factor: 0.9	Frequency: 60Hz	Maximum: 60°C	Weight: 8.82oz	

DIMENSIONS

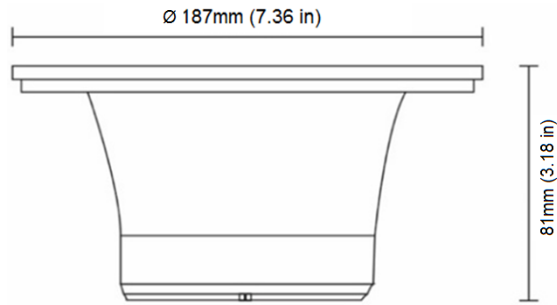

LUMINOUS INTENSITY

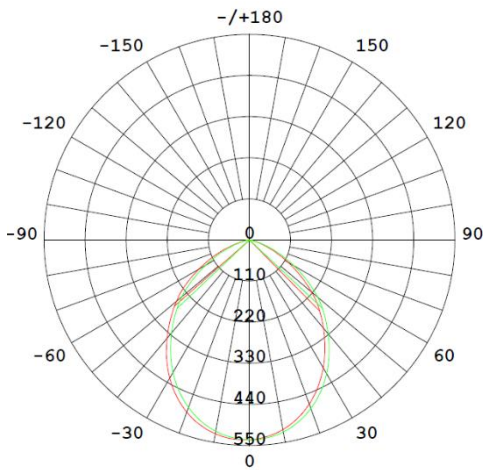

SPECTRAL DISTRIBUTION

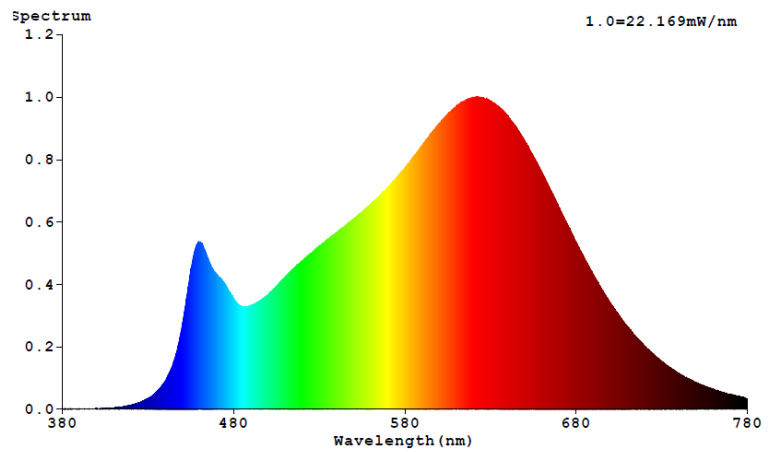

RA – CHART: >90

R VALUES						
R1=93	R2=98	R3=98	R4=92	R5=93	R6=97	R7=90
R8=80	R9=57	R10=94	R11=93	R12=85	R13=94	R14=100

